



Zivid Two User Guide

Revision: 1.0

Date: 01/09/2021

Ordering code: ZVD2

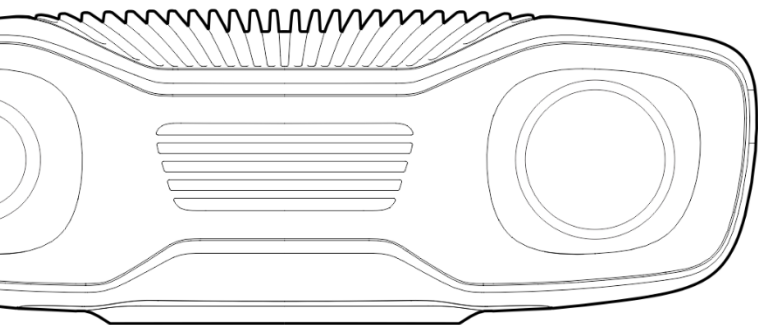

Table of Contents

1. Regulatory Information	3
1.1 Compliance	3
1.2 Safety Precautions	4
2. Unboxing	5
3. System Requirements	6
4. Mechanical Installation	7
4.1 Working Distance and Field-of-View	7
4.2 Mechanical Interface	8
4.3 Available Mounts	9
4.4 Flatness of Mounting Surface	10
4.5 Positioning Correctly	11
In bin-picking applications	12
Cooling clearance	12
Signal protection	12
5. Connectivity and Power Supply	13
5.1 Connectors	13
Factory reset button	13
5.2 Connecting to the Computer	14
5.3 Network Topology	14
Direct connection	14
Connection via switch	15
5.4 Network Configuration	15
Windows	16
Ubuntu	16
6. Software	17
7. Support and Troubleshooting	18
8. Service and Maintenance	19
9. About Zivid	20

1. Regulatory Information

1.1 Compliance

The Zivid Two camera is compliant with EN 62368, FCC class B, Canada ICES-003 (B) / NMB-003 (B), KC, CE, and CB environmental standards.

This device complies with part 15 of the FCC Rules. Operation is subject to the following two conditions: (1) This device may not cause harmful interference, and (2) this device must accept any interference received, including interference that may cause undesired operation.

Changes or modifications not expressly approved by the party responsible for compliance could void the user's authority to operate the equipment.

Note

This equipment has been tested and found to comply with the limits for a Class B digital device, pursuant to part 15 of the FCC Rules. These limits are designed to provide reasonable protection against harmful interference in a residential installation.

This equipment generates, uses and can radiate radio frequency energy and, if not installed and used in accordance with the instructions, may cause harmful interference to radio communications. However, there is no guarantee that interference will not occur in a particular installation.

If this equipment does cause harmful interference to radio or television reception, which can be determined by turning the equipment off and on, the user is encouraged to try to correct the interference by one or more of the following measures:

- Reorient or relocate the receiving antenna.
- Increase the separation between the equipment and receiver.
- Connect the equipment into an outlet on a circuit different from that to which the receiver is connected.
- Consult the dealer or an experienced radio/TV technician for help.

Connections and assembly must be performed by competent technicians. Do not connect external I/O signals to the device while it is powered; this may damage the device.

1.2 Safety Precautions

Transport the device in its original packaging or make sure it is properly cushioned during transportation.

The Zivid Two camera use a white light source, which is tested against IEC62471 and is classified as Risk Group 2. IEC 62471 classifies optical radiation sources based on the level of hazard to the skin and eye. Risk group 2 is moderate risk with a maximum exposure time of 100 s.

Do not look directly into the operating lamp. The light source should not pose a hazard to the eyes, due to the aversion response (head turn or eye blink for example) to very bright light sources, but to be on the safe side, one should avoid looking into the camera/projector during operation.

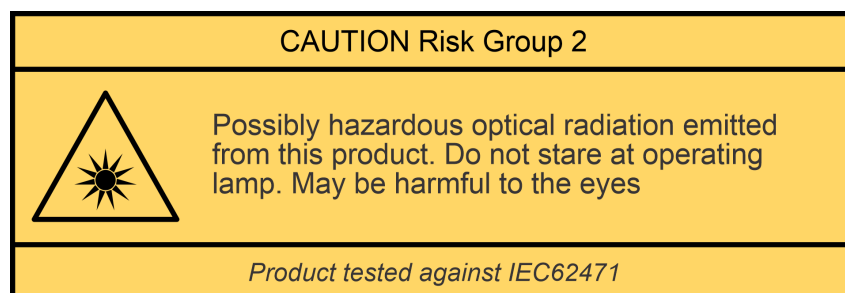

2. Unboxing



Zivid box content:

1. Zivid Two 3D camera
ZVD2
2. 24 V power supply
ZVDA-PWR-xx
3. 5 m power extension cable
ZVDA-CBL-PWR-5M
4. 5 m Ethernet (CAT-6) cable
ZVDA-CBL-ETH-5M

Included in Development Kit:

5. Calibration Board
ZVDA-CB01
6. Stationary
ZVDA-MNT-ST10
7. Tripod Adaptor
ZVDA-MNT-TP20
8. On-Arm Mount
ZVDA-MNT-OA111

3. System Requirements

OS	Windows 10 or Linux Ubuntu 16.04/18.04/20.04
GPU	Dedicated GPU A dedicated GPU gives the best performance with Zivid. It is also the best choice if the GPU will be used for more than Zivid's computations. A medium to high-end AMD or NVIDIA GPU with at least 3 GB of memory is required for optimal performance. This is the preferred solution for Zivid. Recommendations: <ul style="list-style-type: none">• NVIDIA GeForce GTX 1060 or better• NVIDIA GeForce MX150 or better• AMD Radeon RX 550 or better ¹
GPU	CPU with integrated GPU This is the most cost-efficient solution for Zivid. The benefit of an integrated GPU is that the data transfer from GPU to CPU is fast. A high-end integrated GPU with at least 3 GB of memory available is required for optimal performance. Recommendations: <ul style="list-style-type: none">• AMD Ryzen 5 2400G or better ¹• Intel i7 with HD630 or better
Ethernet	Full performance: 10GBASE-T (10G Copper Ethernet) adapter connected via PCI Express or Thunderbolt 3. Reduced performance: 1000BASE-T and NBASE-T (1G, 2.5G and 5G copper) connections

¹Radeon no longer supports SPIR on some GPUs, please verify your GPU drivers support SPIR to be compatible with Zivid Software. Zivid no longer supports AMD on Ubuntu 16.04 (AMD dropped support for Ubuntu 16.04 as of Radeon Software 18.50 for Linux).

4. Mechanical Installation

4.1 Working Distance and Field-of-View

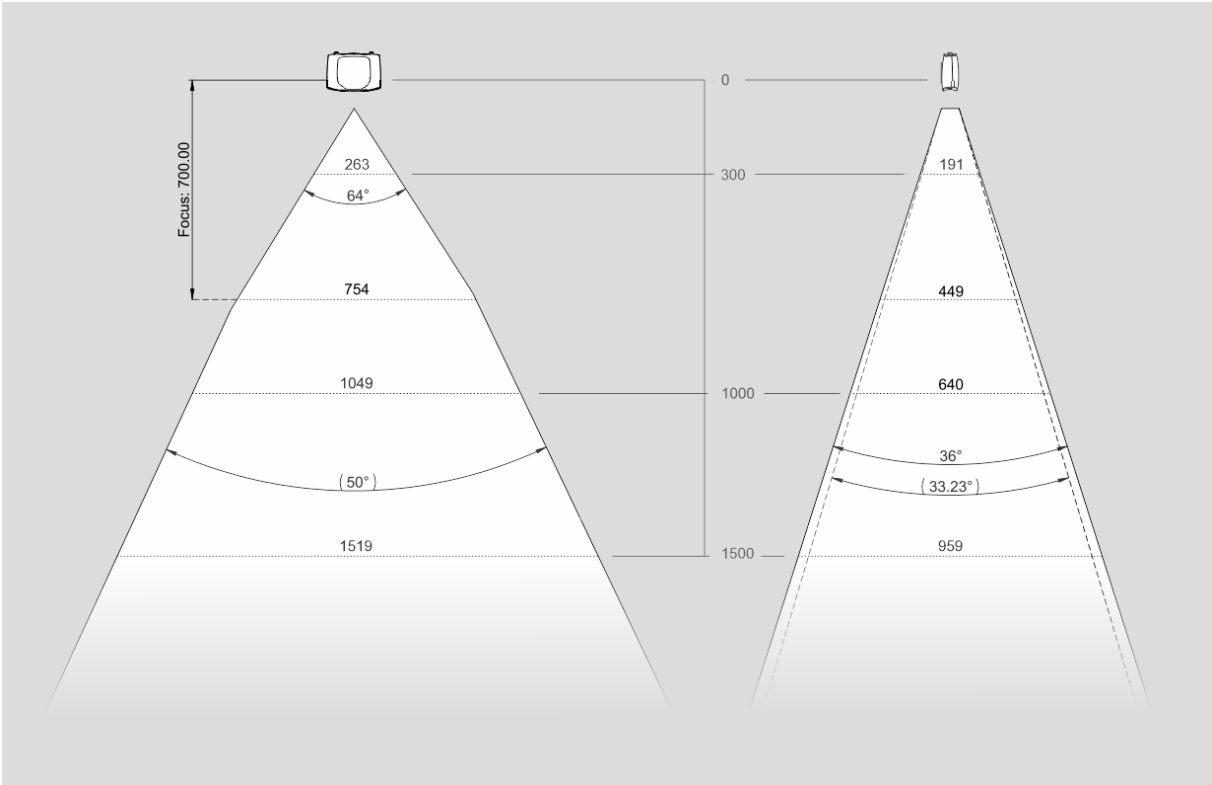

4.2 Mechanical Interface

The Zivid Two camera has three M5 mounting holes, one Ø5 positioning hole, and one Ø5x1 obround alignment hole. We recommend using DIN 912 / ISO 4762 Hexagon or ISO 14579 Hexalobular socket head cap screws in stainless steel (A2 or A4). To ensure not to damage the threads, we recommend not exceeding the specified maximum torque value when fastening the screws.



i Note

The camera must be completely still during the acquisition to deliver the specified 3D image quality. Otherwise, it is completely safe to move it, e.g. when mounted on a robot or any other moving platform.

4.3 Available Mounts



Mounting accessories can be ordered at:
shop.zivid.com



4.4 Flatness of Mounting Surface



For optimal performance we recommend a mounting surface flatness of $\pm 0,05$ mm or better. Mounting the camera to an uneven surface can in some cases affect the calibration.

We recommend using one of the Zivid Camera Mounts to ensure problem free installation of the camera.

4.5 Positioning Correctly

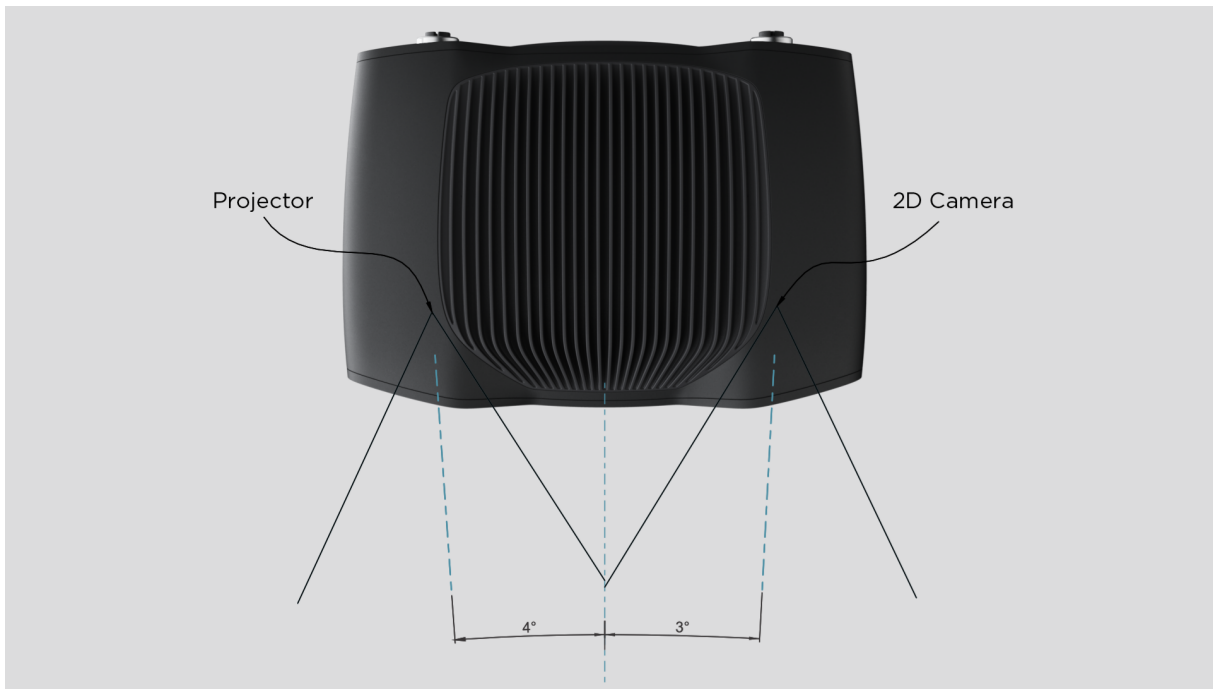

The 2D camera and the projector have an angle of 3 and 4 degrees with respect to the center axis. This should be considered if it is desired to have the camera perpendicular to the scene.

If possible, mount the camera at a slight tilt angle to avoid reflections and interference from the background. This also frees up space above the scene for easier access for tools and robots.

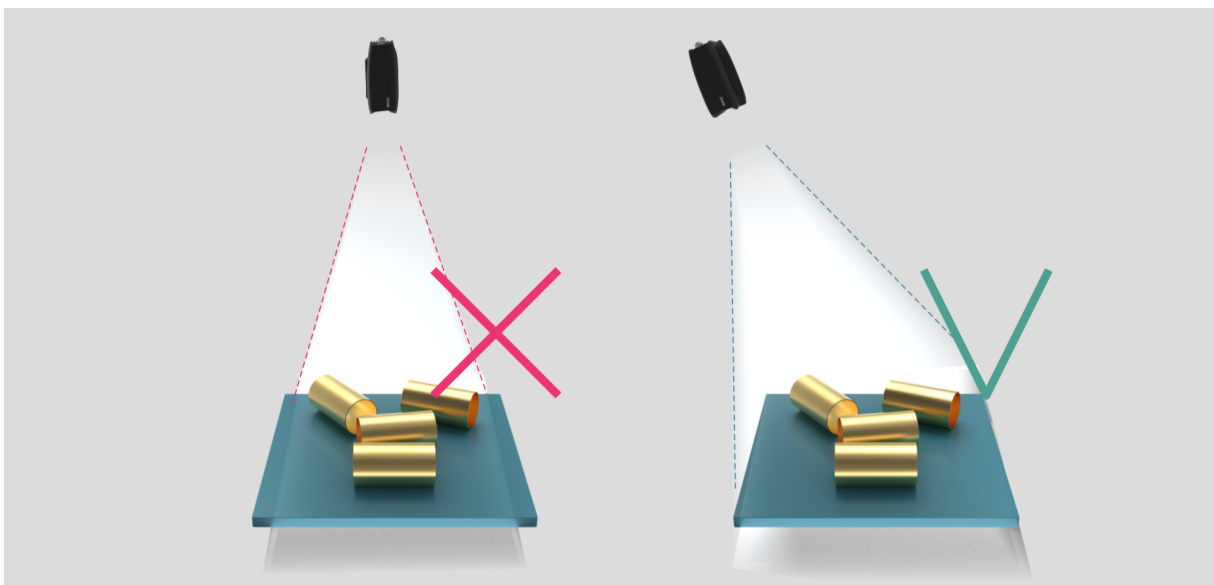

Ambient light might reduce performance. Consider blocking direct light affecting the scene.

In bin-picking applications

For bin-picking applications, place the Zivid camera projector above the back edge or above the rear corner of the bin (see images below). Pan and tilt it so that the 2D camera is looking at the bin center. The projector rays should not fall on the inner surfaces of the two walls closest to the projector; they should almost be parallel to those two walls. Mounting the camera this way minimizes interreflections from the bin walls.

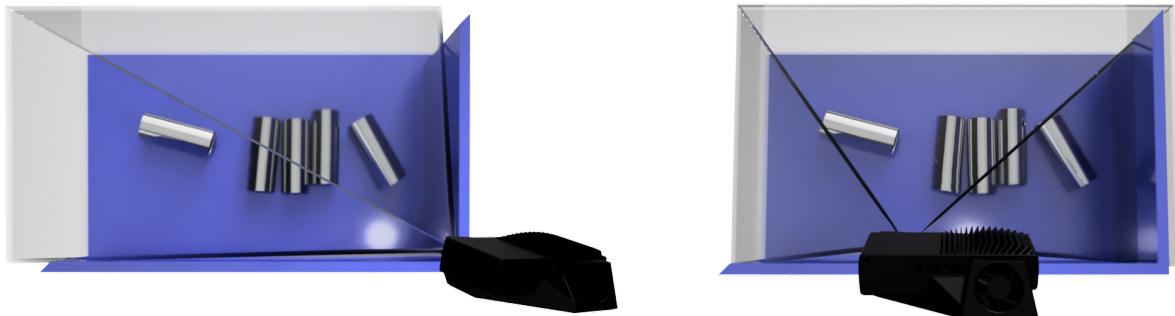

Cooling clearance

Zivid cameras use active and passive cooling, allow some space around the device for airflow, and do not block the air opening on its front and rear sides. Advise the technical specifications for the operating temperature range for your camera.

Signal protection

Do not install Zivid cameras and cables next to high voltage devices that can generate high levels of electromagnetic disturbance. Do not route camera cabling through the same trunks/conduits with AC power cables and cables emitting high levels of disturbance.

5. Connectivity and Power Supply

5.1 Connectors

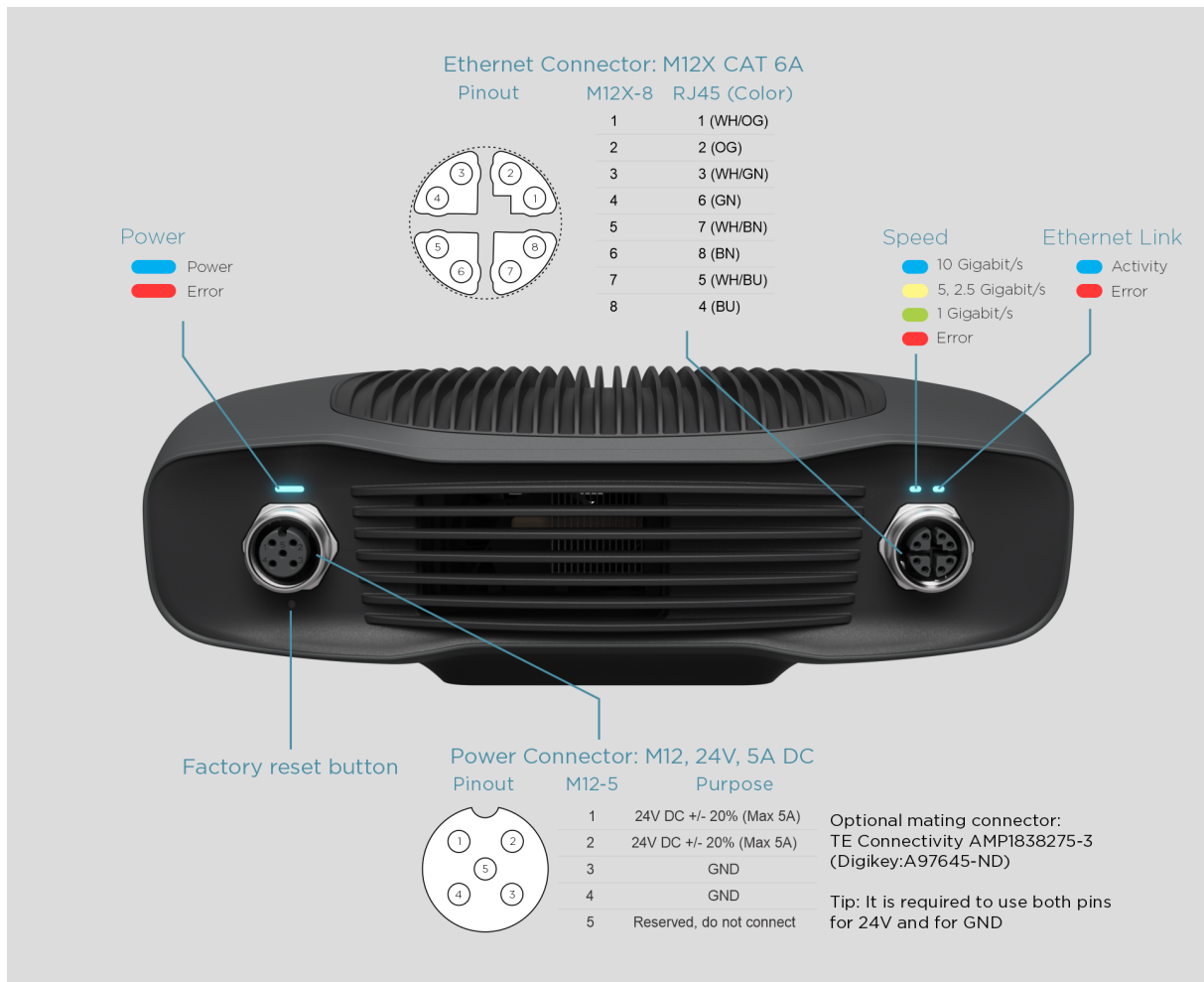

Factory reset button

- Reset (power cycle): Intermittent press or hold for less than 5 seconds.
- Reset to factory IP address: Hold for 5 to 10 seconds until the Power LED turns green.
- Revert to factory installed firmware: Hold for more than 10 seconds until the Power LED turns yellow.

5.2 Connecting to the Computer

1. Plug the power supply into the “24V” port and into a power outlet.
2. Plug the Ethernet cable into the camera and connect it to your computer.

i Note

Ensure that all connections are screwed in tightly. The coupling nut of the M12 screw connectors can in some cases be hard to screw in. However, when installed correctly they provide a robust and reliable connection.

We recommend to use the AC/DC adapter supplied with the unit to ensure compliance with emission and immunity standards.

The Zivid unit is protected against reverse polarity and against overheating by a thermistor that physically removes the power.

The Zivid Two camera uses Ethernet communication and needs 10 Gbps for best performance. Your computer may not have a port for 10 Gigabit Ethernet. In that case, you may connect to it using an adaptor for 10GBASE-T (10 Gbps copper Ethernet) to Thunderbolt 3. At a reduced performance you can also use 1000BASE-T and NBASE-T (1 Gbps, 2.5 Gbps, and 5 Gbps over copper) to USB adapters.

Use only Zivid approved Ethernet cables.

5.3 Network Topology

Zivid Two supports the following network topologies:

Direct connection

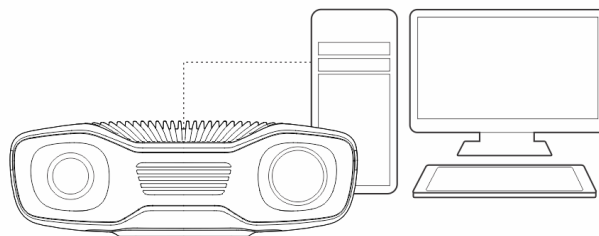

Connection via switch

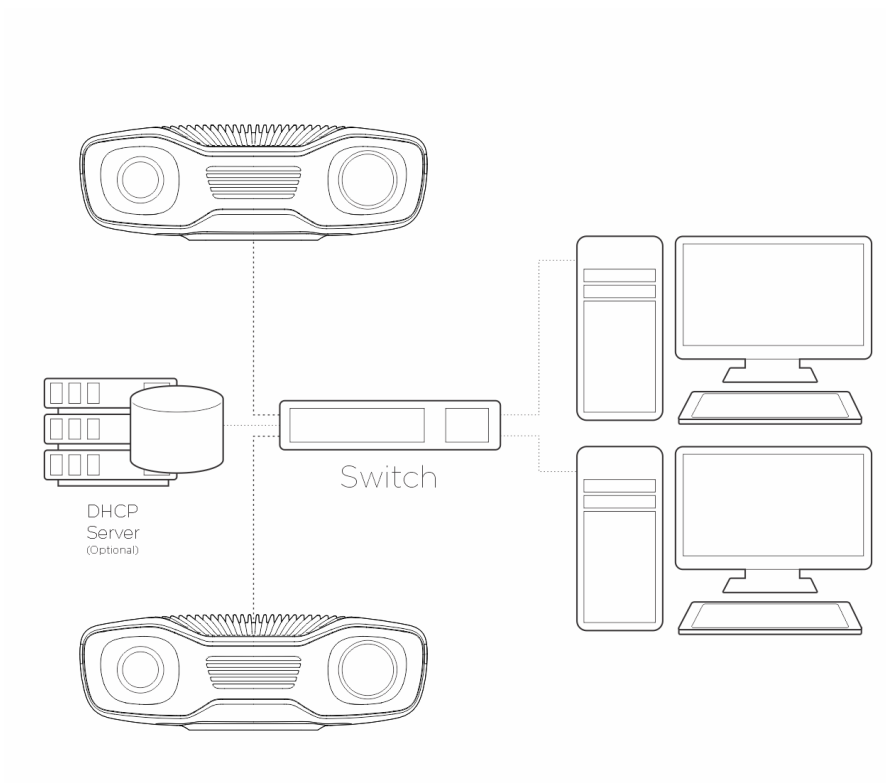

5.4 Network Configuration

The Zivid Two camera uses Ethernet communication and needs 10 Gbps for best performance. Your computer may not have a port for 10 Gigabit Ethernet. In that case, you can connect to it using an adaptor for 10GBASE-T (10 Gbps copper Ethernet) to Thunderbolt 3. At a reduced performance you can also use 1000BASE-T and NBASE-T (1 Gbps, 2.5 Gbps, and 5 Gbps over copper) to USB adapters.

Zivid Two has a factory default IP address: 172.28.60.5. To connect to the camera you must set up the network interface.

IP address: 172.28.60.1

Subnet mask: 255.255.255.0

Windows

Right click on your network connection and chose Properties.

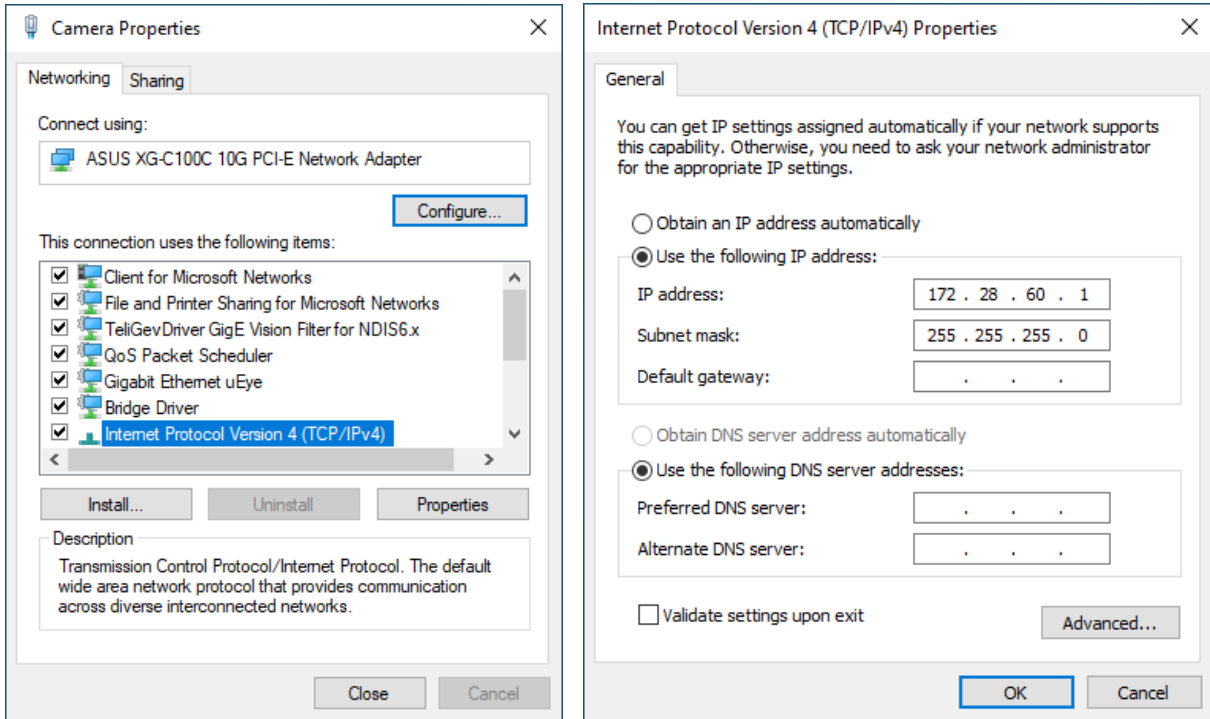

Ubuntu

Set up the network configuration in the IPv4 tab.

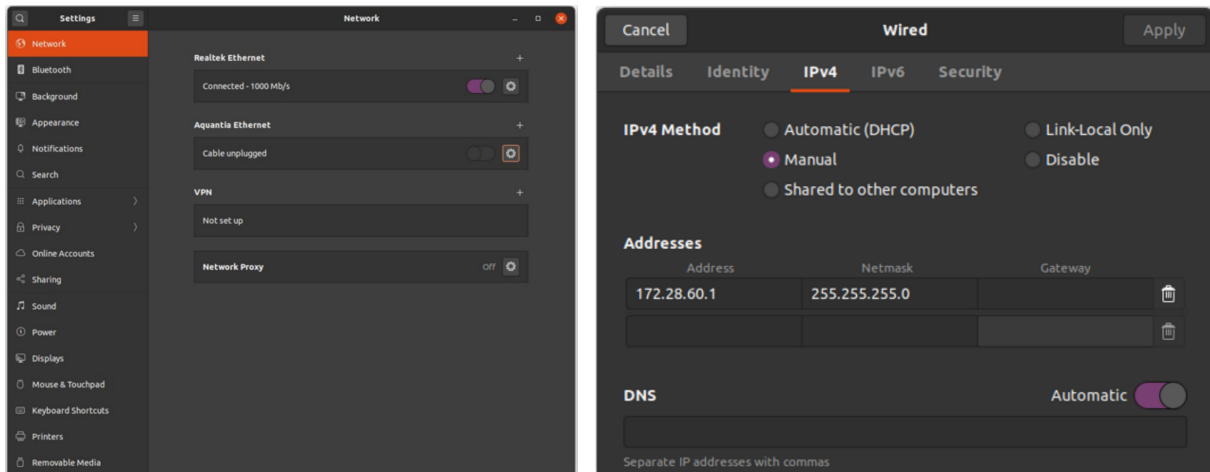

6. Software

To download the latest software for your camera, navigate to:

www.zivid.com/downloads



Visit the Knowledge Base for the installation guide, and then navigate to the Zivid Studio user guide to learn how to capture your first point clouds:

support.zivid.com

7. Support and Troubleshooting

For more information, visit:

support.zivid.com



The Zivid Knowledge Base provides answers for commonly seen issues and questions related to Zivid products, for both software and hardware. You will also find in depth articles about our camera technology, best use practices, different types of 3D imaging methods and structured light, to get a better understanding for how to use this product.

8. Service and Maintenance

The device contains no user-serviceable parts inside. The product warranty will be void if opened.

Follow the below instructions to ensure that your Zivid camera is well maintained:

- Check screw connections and connectors at regular intervals.
- Do not block the air opening on the front and rear sides of the product.
- The unit uses active and passive cooling, allow some space around the device for airflow.
- Use a small vacuum cleaner or a small canister of compressed air to remove dust or other accumulated particles from the glasses or in between the ribs of the heat sink.
- Regularly clean optical glass parts of the device.
- Check and update the calibration on a yearly basis by performing Infield Correction (and Hand-Eye Calibration) when necessary.

9. About Zivid

Zivid is a market-leading provider of 3D machine vision cameras and software for next generation robotics and industrial automation systems. Its Zivid One⁺ and Zivid Two products are regarded as the world's most accurate real-time 3D color cameras and bring human-like vision to the smart factories and warehouses of Industry 4.0.

To find out more about Zivid, visit:

www.zivid.com



Email

Technical support: customersuccess@zivid.com

Sales: sales@zivid.com

General: info@zivid.com

Phone

Zivid HQ-Oslo, NO | +47 21 02 24 72

Zivid Sales-Austin, TX, US | +1 (847) 345-7691

Zivid Sales-Xiamen, CN | +86 139 5012 9074

Zivid Sales-Seoul, KR | +82 10 8984 5350

Zivid
Gjerdrums vei 10A
0484
Oslo, Norway

©23/08/2021, Zivid. All rights reserved. Subject to change without notice.

ZiVID
See more. Do more.